

Operating instructios

Falcon  FT5010



Falcon 
Business
Whole new experiance

Table of contents

Technical Description	1
Putting into service	2
Dialing call numbers	3
Using the telephone memory	4
Advanced operations	5
Adjsuting telephone settings	6
Adjsuting telephone settings	7
Operation at private PBXs	8
Wall mounting	10

Technical Description



Key functions:

- | | | | |
|--|---|--|---|
| | Set key | | Pause key |
| | Recall key | | Mute key |
| | Redial key | | Handsfree key /
Speaker & message waiting lamp |
| | Volume keys | | Repertory keys |
| | Repertory keys
(While pressing shift) | | Speed dialing
(Combined with keypad) |

"New message" display (at private PBX)

If your PBX supplies active message service, you can get notification for pending voice messages.

When new messages are received, the message waiting lamp will blink rapidly. After you listen and delete all pending messages, the lamp will turn off.

Putting into service

Safety precautions

For your safety and protection, do not operate the telephone in bathrooms or showers (damp environments). The telephone is not splashproof.

Dispose of the telephone in an environmentally friendly manner in accordance with the relevant legislation.

Do not forget to include the User's Guide when passing on your Falcon FT5010 to a third party.

Recommendations for telephone installation

- Do not expose the telephone to direct sunlight or other heat sources.
- Operation at temperatures between +5°C and +40°C.
- A distance of at least one meter must be observed between the telephone and radio equipment, such as radio telephones, radio paging devices or TVs. Otherwise telephone traffic can be affected.
- Do not install the telephone in rooms where large quantities of dust accumulate as this can considerably reduce the service life of the telephone.
- To clean the telephone, simply wipe it with a damp cloth or an antistatic wipe. Never use a dry cloth (danger of electrostatic discharge) or abrasive cleaning agents!
- Contact with unit parts (e.g. rubber feet) can leave marks on surface finishes applied to furniture.

Connections

Plug the short end of the handset spiral cable to the handset, and the long end to the jack marked with  at the bottom part of the phone.

Plug one end of the telephone cable to the line jack, and the other end to the jack marked with  at the bottom part of the phone. Look at the image to determine the right way of installation, depending on desktop installation or wall mounting.

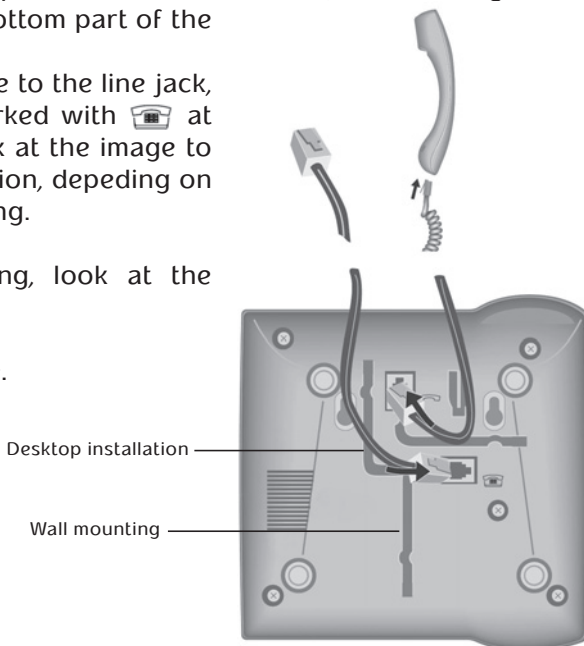

If you want to use wall mounting, look at the description on pg. 10.

Now, the telephone is ready for use.



Dialing call numbers



Dialing call numbers

  Lift the handset, and dial the call number.

Activating/deactivating handsfree talking

With this telephone you can also make calls (handsfree mode) or settings without lifting the handset. The best distance from the microphone for speaking is about 50cm.

Activating during a call via the handset

  Press Handsfree key and replace the handset.

Activating before dialling the number

 Before dialling: hold down the Handsfree key until you can hear the dialling tone.

Deactivating handsfree talking

 Lift the handset during the call.

Last number redial

The last number dialed is automatically saved (max. 31 digits).

  Lift the handset, press the redial key.

Recall key

 During a call, to answer a call waiting, press the Recall key.

Using the telephone memory

Saving and dialing repertory numbers

You can save up to 16 call numbers using the two levels of the repertory keys.

Saving:



Lift the handset, then press the set key.



Press the repertory key under which the repertory call number is to be stored.

or...



Press shift key for the 2nd storage level and press repertory key.



Enter the call number to be stored (max. 21 digits)



Press the set key then replace the handset.

To dial numbers:



Lift handset.



Press repertory key.

or...



Press shift key for the 2nd storage level and press repertory key.

Saving and dialing speed dialing numbers

Saving:



Lift the handset, then press the set key.



Press speed dial key and speed dial number (number key).



Enter the call number to be stored (max. 21 digits)



Press the set key then replace the handset.

Dialing:



Lift handset, press speed dial key



Press speed dial number (number key).

Note:

- Numbers longer than 21 digits cannot be saved.
- Saving a number will delete the previous content of the memory.

Advanced operations

Dialling pauses

One or more dialling pauses (not at 1st digit) can be entered using **(P)**. Pauses are transferred to the memory and are necessary for certain extension systems (e.g.: 0 **(P)** 2368).

Dialling a dialling pause within the first 5 digits: The entire number saved is dialled, including the 1-second dialling pause.

Dialling a dialling pause after the first 5 digits: The portion of the number saved after the pause is only dialled after pressing **(P)**.

Mute

You can deactivate the telephone handset and microphone during a call. Neither you nor the called party will hear each other. The connection is maintained.





 Press the mute key during the call.

To reactivate the handset and microphone:

 Press the key again.

Easy key lock

The telephone can be locked completely so that it cannot dial any phone numbers. You can continue to receive incoming calls.

     Lift the handset, press "Set" 5, 3, 9 to toggle between locked and unlocked (default setting :unlocked).



  Press the set key, then replace the handset.

Adjusting telephone settings

Adjusting the ringer volume

The volume of the ringer can be set to one of 3 levels and can also be deactivated completely (default setting: level 3).

   Lift the handset, then start the function.

 ...  Press one of the keys 1...3:1-highest frequency; 3-lowest frequency.

  Press the set key, then replace the handset.

or...

   Lift the handset.

  Adjust the volume with the up/down key.



  Press the set key, then replace the handset.

Setting the ringtone

Five different ringtones can be set for the ringer (default setting: ringtone 0).



To set with the telephone is idle:

   Lift the handset, then start the function.

 ...  Press one of the keys 0...4

  Press the set key, then replace the handset.

To set while the telephone is ringing:

 ...  Press one of the keys 0...4

On / Off the ringer

   Lift the handset, then start the function.

 /  Press one of the keys (0=Ringer off, 1 = Ringer on).

  Press the set key, then replace the handset.

Adjusting handset volume

The volume of the handset can be set to one of 5 levels.

 Lift the handset.

  Adjust the volume with the up/down key.

 Replace the handset.

Adjusting speaker volume



The volume of the speaker can be set to one of 9 levels.

  With handsfree activated, adjust the volume using the up/down key.

Adjusting telephone settings

Switching the dialling mode

   Lift the handset, then start the function.



 /  0 = Pulse mode (default setting)

1 = DTMF mode

  Press the set key, then replace the handset.

Select pause duration

   Lift the handset, then start the function.

 /  Select 0 = 1 sec (default setting) or 1 = 3 sec

  Press the set key, then replace the handset.

Reset to factory settings

A PIN code is available for protection various user. The default PIN code is set to 1111. It is possible to reset all settings to the default factory settings with following procedure:

Lift the handset, then start the function.

  Press the set key, then replace the handset.

Note: The numbers that are programmed into Repertory keys / Speed dial will not be deleted.

Operation at private PBXs

Setting exchange code

When saving number, it's possible to enter Pause, to get outside line at PBX. For details, look at "Dialing Pause" on pg. 5.



Recall key (use on private PBXs)



During a trunk call, you can make an enquiry call or transfer a call.

To do this, press the recall key . The next step depends on your PBX. In the factory setting, the recall key function is set to a flash time (interrupt time) of 285ms to permit new features to be used on public telephone systems. When your telephone is connected to a private PBX, it may be necessary to change the flash time (e.g. 101ms). Please check the operating instructions for your PABX.

Note: Recall key is also used to initiate conference call, when the PBX allows the function.

Setting the flash time for the recall key

   Lift the handset, then start the function.

 /  Select 0 or 1 (0 = 101ms, 1=285ms default)

  Press the set key, then replace the handset.

If your telephone is not functioning correctly

- Handset off-hook, no dial tone:

Is the connecting cord correctly inserted in the telephone and the wall socket?

- A dial tone is audible, but dialling is not possible:

The connection is OK. Is the dialling mode correctly set? See Switching the dialling mode.

- PBXs only: Connection fails or is incorrect when a number is dialled from memory (e.g. redial, speed dialling):

Program the exchange code.

- Recall key not working:

Set a suitable flash time.

Wall mounting

Wall mounting diagram

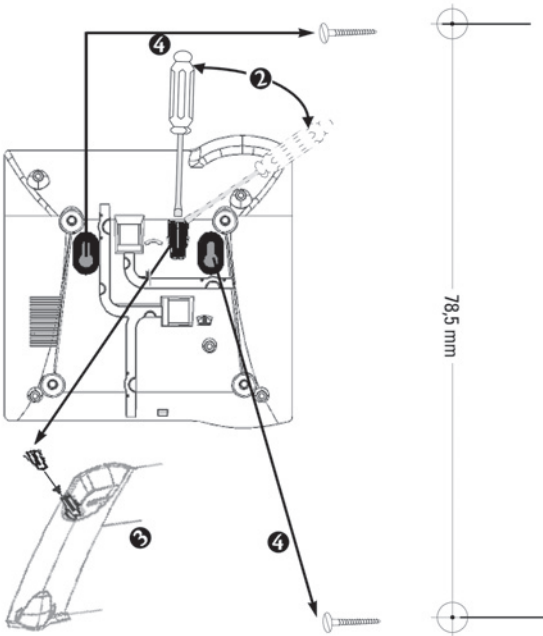

You can install the telephone on the wall once the connecting cords have been attached:

1. Using the template provided, drill two holes (5 mm). Insert dowel plugs and screw in flat-head wood screws leaving a slight gap between the screw head and the wall (screws must not be flush).
2. On the underside of the telephone: use a screwdriver to remove the handset locking pin.
3. Insert the handset locking pin in the handset cradle.
4. Hang the telephone from the protruding screw heads.